

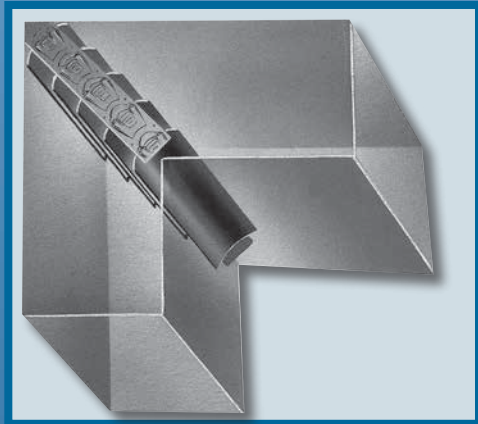

# FLEXIBLE DUCT CONNECTOR & VANE RAIL



# PRODUCT CATALOG



# PRE-ASSEMBLED FLEXIBLE DUCT CONNECTOR

ELIMINATES DUCT SYSTEM NOISES AND VIBRATIONS

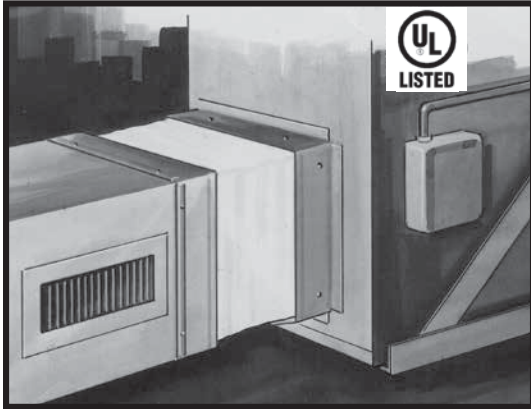

All air duct installations for heating, cooling or ventilation are attached to mechanical equipment containing a fan or blower. Vibrations, noises and rattles resulting from the operation of the fan or blower are transmitted into the metal ducts which carry the noises throughout the system.

In order to isolate the vibration and noises to the source, an air-tight flexible joint, consisting of a fabric which is secured to sheet metal on both sides, must be inserted between the equipment and the ductwork. This flexible joint is called a "Flexible Duct Connector."

To meet every type of installation requirement, whether it be for factory, institution, office or home; Duro Dyne offers the widest variety of flexible duct connector fabrics (U.L. Classified) and sizes; pre-assembled with the sheet metal permanently secured to the fabric by means of exclusive seam locks. Duro Dyne Flexible Duct Connectors are dispensed from the carton, ready to complete fabrication faster, more efficiently, and more economically than any conventional method.

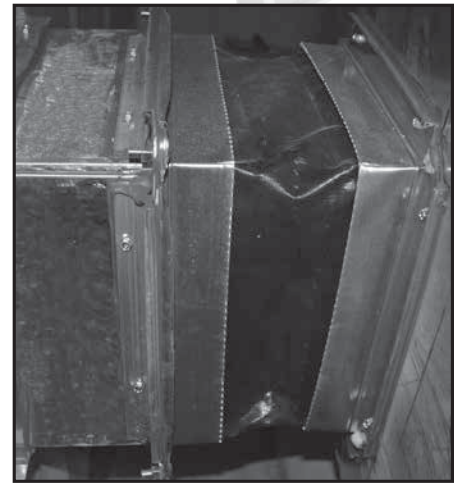

- All Duro Dyne Fabrics\* are designed to meet NFPA 701 (formerly UL 214.)
- All Duro Dyne Fabrics\* are designed to meet NFPA 90A & 90B.
- All Duro Dyne Fabrics are airtight and waterproof.
- Duro Dyne meets or exceeds the SMACNA steel requirements for flexible duct connector.
- All Duro Dyne Flexible Duct Connector utilize 24 or 28 gauge galvanized steel meeting ASTM-A-525 G60.
- Standard roll length - 100 ft.
- Certain Connectors are available with 300L series or 316L series stainless steel or aluminum. (See chart on pages 4-5 for availability)
- Flexible Duct Connector is manufactured in the United States for all markets and in the U.A.E. for Mid East and Overseas markets.
- Vane Rail is manufactured in the United States.

CANVAS, OTHER FABRICS & SIZES AVAILABLE AS SPECIAL ORDER.  
\*CANVAS TREATED TO MIL SPEC CCC-C-428 G ONLY

NOTE: All specification values shown in this catalog are typical and will vary within accepted commercial tolerances.

## GRIP LOC™

The double-lock gripping fingers of metal-to-fabrics adds tremendously to the holding power compared to the conventional singlefold method. Grip Loc is standard on Metal-Fab and Super Metal-Fab.

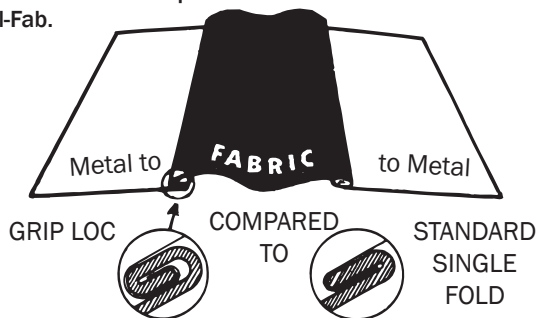

## GUARD LOC™

Another Duro Dyne exclusive - Shielded with metal on both sides at the seam, Guard Loc forms a tough metal-to-fabric bond. Forming in a brake is simpler, and Guard Loc prevents tears in the fabric because of unique metal-shielded seams. Guard Loc is standard in Econ-O-Fab, Junior and Insulflex Connector.

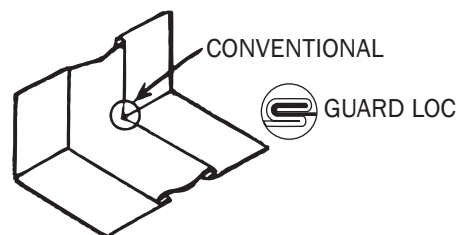

All Duro Dyne Flexible Duct Connector Products are suitable for pressures of -10 to +15 wg. Duro Dyne's standard 'single fold' metal to fabric grip has been tested by an independent testing laboratory to withstand a negative pressure of -10"WC and a positive pressure of +17.25" WC with no tearing or visible separation.

# INDUSTRIAL/COMMERCIAL APPLICATIONS

METAL-FAB®	SPECIFICATIONS
Metal-Fab is constructed of material which meets the requirements of heavy commercial systems. This factory fabricated flexible duct connection will allow for normal vibration in large duct systems without inhibiting the effectiveness of the flexible duct connector. <i>*Certain connectors available in 300L Series Stainless Steel.</i>	Gauge: 24 Galvanized
	Dimensions: 3" metal - 3" fabric - 3" metal
	Fabrics Supplied: Durolon, Excelon®, Neoprene, Glasseal, Thermafab®, Teflon
	Seam: Grip Loc

SUPER METAL-FAB®	SPECIFICATIONS
Super Meta-Fab is constructed of material to provide for special commercial duct systems. Very large equipment can cause excessive vibration; to compensate for this, a wider fabric is used to eliminate the transmission of vibration to the duct. <i>*Certain connectors available in 300L Series Stainless Steel.</i>	Gauge: 24 Galvanized
	Dimensions: 3" metal - 6" fabric - 3" metal
	Fabrics Supplied: Durolon, Excelon®, Neoprene, Glasseal, Thermafab®
	Seam: Grip Loc

TDC/TDF CONNECTOR	SPECIFICATIONS
TDC/TDF Connector has ample material for roll forming a connecting flange on both sides of the flexible connection. This product is designed to be compatible with both TDC (Lockformer) and TDF (Engel) roll forming flange-fabricating equipment. <i>*Certain connectors available in 300L Series and 316L Series Stainless Steel.</i>	Gauge: 24 Galvanized
	Dimensions: 4" metal - 4" fabric - 4" metal
	Fabrics Supplied: Durolon, Excelon®, Neoprene, Glasseal, Thermafab®, Dynalon, Teflon
	Seam: Grip Loc
	Also Available: 4" metal -6" fabric -4" metal

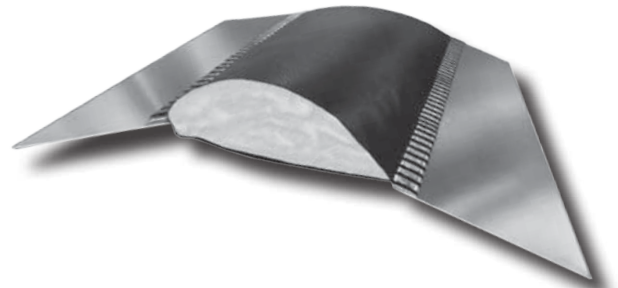
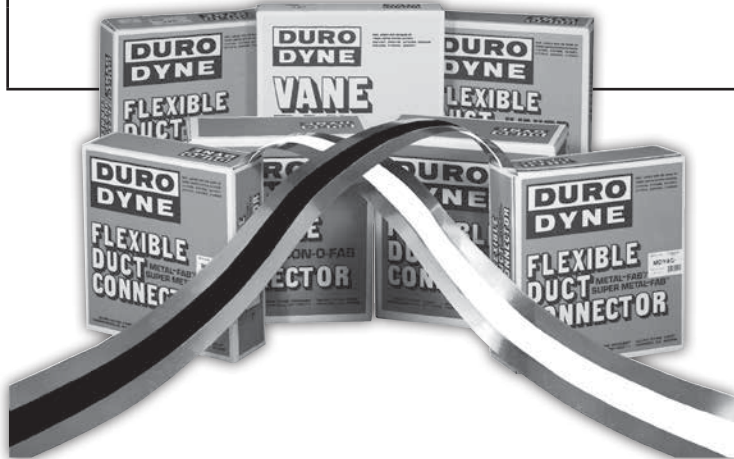



# RESIDENTIAL/LIGHT COMMERCIAL APPLICATIONS

ECON-O-FAB®	SPECIFICATIONS
For light commercial or larger residential systems.	Gauge: 28 Galvanized
	Dimensions: 2 ¾" metal - 4" fabric - 2 ¾" metal
	Fabrics Supplied: Durolon, Excelon®, Neoprene, Glasseal, Thermafab®
	Seam: Guard Loc

JUNIOR CONNECTOR	SPECIFICATIONS
For residential systems.	Gauge: 28 Galvanized
	Dimensions: 1 ¾" metal - 3" fabric - 1 ¾" metal
	Fabrics Supplied: Durolon, Excelon®, Neoprene, Glasseal, Thermafab®, Dynalon®
	Seam: Guard Loc

Reference: All steel gauges are as per SMACNA Standard, Appendix A-A.1 in *The HVAC Duct Construction Standards Metal and Flexible Third Edition 2005.*

# FABRICS

FABRIC COMPARISONS	Excelon®	Neoprene (Standard Grade)	Neoprene (Specification Grade)	Durolon
<b>UL Classified Listing #</b>	R4462	R4462	R4462	R4462
<b>Continuous Temp. Range</b>	-40°F. to 180°F.	-40°F. to 200°F.	-40°F. to 200°F.	-40°F. to 250°F.
<b>Color</b>	Black	Black	Black	White
<b>Commercial Grade Weight</b>	22 oz.	22 oz.	30 oz.	26 oz.
<b>Residential Grade Weight</b>	17 oz.	22 oz.	30 oz.	26 oz.
<b>Abrasion Resistance<sup>1</sup></b>	15,000 cycles	600 cycles	600 cycles	500 cycles
<b>Leakage Resistance<sup>2</sup></b>	350	595	595	250
<b>Tear Strength<sup>3</sup></b>	100 lbs. / 100 lbs.	12 lbs. / 12 lbs.	12 lbs. / 12 lbs.	12 lbs. / 12 lbs.
<b>Tensile Strength<sup>4</sup></b>	240 lbs. / 220 lbs.	500 lbs. / 450 lbs.	500 lbs. / 450 lbs.	225 lbs. / 300 lbs.
<b>Base Fabric</b>	Woven Nylon/Polyester Blend	Woven Fiberglass	Woven Fiberglass	Woven Fiberglass
<b>Coating</b>	Vinyl	Neoprene	Neoprene	Hypalon
<b>Features</b>	<ul style="list-style-type: none"> <li>• Excellent water resistance</li> <li>• Excellent tear strength</li> <li>• Excellent all purpose fabric</li> <li>• Unaffected by mildew</li> </ul>	<ul style="list-style-type: none"> <li>• Extremely resistant to alkalis &amp; gasoline</li> <li>• Excellent on systems exposed to toxic fumes</li> <li>• Good general purpose fabric</li> <li>• Unaffected by mildew</li> </ul>	<ul style="list-style-type: none"> <li>• Extremely resistant to alkalis &amp; gasoline</li> <li>• Excellent on systems exposed to toxic fumes</li> <li>• Good general purpose fabric</li> <li>• Unaffected by mildew</li> </ul>	<ul style="list-style-type: none"> <li>• Excellent ozone resistance</li> <li>• Excellent resistance to weathering</li> <li>• Best overall acid resistance</li> <li>• Recommended for rooftop applications</li> <li>• Unaffected by mildew</li> </ul>
<b>Codes</b>				
<b>Metal-Fab®</b> <b>3x3x3</b> <b>Grip Loc</b> 	MBX333 (#10159) <b>Aluminum:</b> MBXAL333 (#10168) <b>Stainless:</b> MBXSS333 (#10231)	MLN333 (#10105)	MFN333 (#10003) <b>Aluminum:</b> MFNAL333 (#10098) <b>Stainless:</b> MFNSS333 (#10232)	MFD333 (#10002) <b>Aluminum:</b> MFDAL333 (#10097) <b>Stainless:</b> MFDSS333 (#10234)
<b>Super Metal-Fab®</b> <b>3x6x3</b> <b>Grip Loc</b> 	MB6X363 (#10160)	ML6N363 (#10148)	MF6N363 (#10012)	MF6D363 (#10011)
<b>TDC/TDF</b> <b>4x4x4</b> <b>Grip Loc</b>   <b>*4x6x4 also noted</b>	MBX444 (#10210) MBX464* (#10214) <b>Aluminum:</b> MBXAL444 (#10258) <b>Stainless:</b> MBXSS444 (#10259) MBX316SS444 (#10275) MBXSS464* (#10262)	Not Available	MFN444 (#10211) MFN464* (#10246) <b>Stainless:</b> MFNSS444 (#10260)	MFD444 (#10237) MFD464* (#10245) <b>Stainless:</b> MFD316SS444 (#10276)
<b>Econ-O-Fab® Guard Loc</b>	EBX (#10171)	EFN (#10035)	Not Available	EFD (#10034)
<b>Junior Guard Loc</b>	JBX (#10169)	JRN (#10028)	Not Available	JRD (#10027)
<b>Fabric Only (100ft. length)</b>	DBX6 (#10161) 6" wide DBX10 (#10162) 10" wide	Not Available	DFN6 (#10043) 6" wide DFN10 (#10051) 10" wide	DFD6 (#10042) 6" wide DFD10 (#10050) 10" wide

All Duro Dyne Flexible Duct Connector utilize 24 or 28 gauge galvanized steel meeting ASTM-A-653 G60; other materials are available upon request. Stainless Steel configurations utilize 300L or 316L grade material. Aluminum configurations have an alloy and temp: 3003-H14 and thickness: .032".



<b>Insulflex®*</b>	<b>Thermafab®</b>	<b>Teflon</b>	<b>Glaseal</b>
n/a	R4462	n/a	R4462
-40°F. to 180°F.	-65°F. to 500°F.	-150°F. to 500°F.	-40°F. to 180°F.
Black	Grey	Grey Outside/ Beige Inside	Grey & Black
28 oz. (composite weight)	17 oz.	16.5 oz.	16 oz.
28 oz. (composite weight)	17 oz.	16.5 oz.	16 oz.
500 cycles	125 cycles	1,000 cycles	1,400 cycles
125	400	650	120
8 lbs. / 11 lbs.	50 lbs. / 40 lbs.	50 lbs. / 30 lbs.	8 lbs. / 9 lbs.
70 lbs. / 70 lbs.	200 lbs. / 150 lbs.	400 lbs. / 300 lbs.	90 lbs. / 90 lbs.
Polyester	Woven Fiberglass	Fiberglass/Satin Weave	Woven Fiberglass
Vinyl	Silicon Rubber	Teflon	Vinyl
<ul style="list-style-type: none"> <li>• Low Smoke Emission</li> <li>• Insulated 3-4-3 Configuration</li> </ul>	<ul style="list-style-type: none"> <li>• Excellent high temp. resistance</li> <li>• Excellent low temp. resistance</li> <li>• Excellent chemical resistance</li> <li>• Extremely low smoke emission</li> <li>• Excellent ozone resistance</li> <li>• Excellent resistance to weathering</li> <li>• Unaffected by mildew</li> </ul>	<ul style="list-style-type: none"> <li>• High temperature resistant</li> <li>• High corrosion resistance</li> <li>• Excellent chemical resistance</li> </ul>	<ul style="list-style-type: none"> <li>• Good, low cost</li> <li>• Resistant to acids &amp; chemical fumes</li> <li>• Resistant to grease &amp; alkalies</li> <li>• Unaffected by mildew</li> </ul>
IDC343 (#10173) *Gauge: 28 †Guard Loc	MFT333 (#10005)	MCT333 (#10278) <b>Stainless:</b> MCTSS333 (#10292)	MGL333 (#10004)
Not Available	MF6T363 (#10013)	Not Available	MF6G363 (#10016)
Not Available	Not Available	MCT444 (#10279) <b>Stainless:</b> MCTSS444 (#10293)	Not Available
Not Available	EFT (#10037)	Not Available	EGL (#10036)
Not Available	JRT (#10030)	Not Available	JGL (#10029)
Not Available	DFT6 (#10045) 6" wide DFT10 (#10053) 10" wide	Not Available	DGL6 (#10044) 6" wide DGL10 (#10052) 10" wide

**Notes:**

1. Abrasion resistance as per Federal Test Standard 191 Method #5306 using CS 17 wheel with 250 Gram load.
2. Leakage resistance as per Federal Test Standard 191 Method #5512. Results in P.S.I. (To convert inches of water multiply P.S.I. x 27.176.).
3. Tear strength in tongue pounds as per Federal Test Standard 191 Method #5134.1 (warp/fill).
4. Tensile strength in grab pounds as per Federal Test Standard 191 Method #5100 (warp/fill).
5. Standard Excelon is not LA city approved. Use Excelon-LA when LA city approval is necessary. (See Specification Form Excelon-LA - 203)
6. Duro Dyne Neoprene, Durolon, Teflon, Thermafab and Excelon fabrics were subjected to a 1000 hour accelerated weathering and UV test per ASTM G155 with no noticeable signs of degradation.

# FABRICATING A FLEXIBLE CONNECTION

## HOW TO STIFFEN FLEXIBLE CONNECTOR

When installing large size flexible connectors in a duct system, some type of stiffening agent is usually required to keep the unit relatively rigid. Some contractors use angle iron, while in many cases a bar slip connection is used to achieve this result. Now it is possible to save valuable time and material by forming Duro Dyne's Grip Loc Seam found on Metal Fab and Super Metal Fab, to rigidize the connector over long sections. This simple method of stiffening the sides of Duro Dyne's Flexible Connector can eliminate the costly addition of angle iron used to perform this job.

### HERE IS HOW IT IS DONE:

1. Lay out Connector as you normally do.

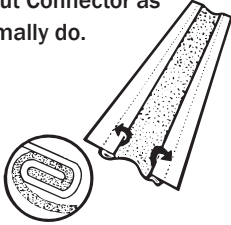

2. Bend the Grip Loc seam up to 90° on a brake as indicated in the drawing.

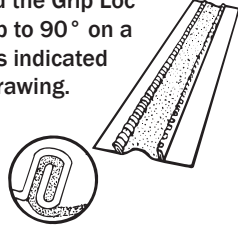

3. Using a heavy snips, notch the seam at the bend points.

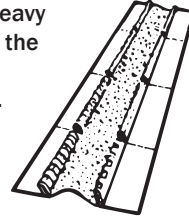

4. Bend to form a completed connector.

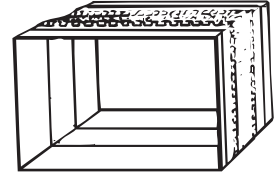

Note: The stiffening method illustrated here is recommended only with the Duro Dyne Grip Loc Connector.

## HOW TO SEAM FLEXIBLE CONNECTOR

Here is how we suggest the ends of the Connector be prepared for making a joint:

1. Cut through center of the lock as indicated. Cut 1" to 1-1/2" deep to allow sufficient lap.

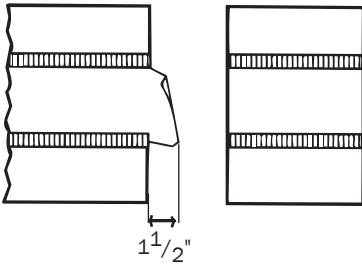

2. From the edge of the connector, cut away metal as indicated. The metal falls away exposing the fabric ready for seaming.

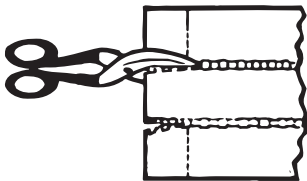

3. You have two options to finish your joint.  
A. FCA  
B. Duro Stapler with Quad Seal

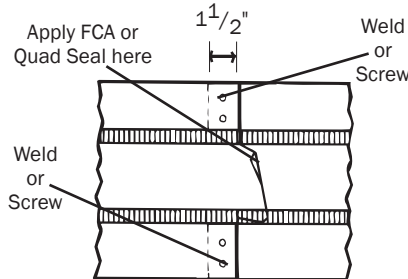

3A. Apply one or two lines of FCA, sparingly, on the fabric, under the tongue. Press the tongue down on the adhesive. Rub the seam gently and hold it for 10 seconds. FCA can be used with Excelon, Neoprene, Durolon and Glasseal. Not recommended for bonding Teflon.



FCA Adhesive  
1 oz. bottles  
Item# 5090

3B. Put a liberal amount of Red Heat Resistant Silicone between the two fabric flaps and press the two pieces together to allow the silicone to spread. Roll the flap ends together and staple the seal (going through both pieces of fabric and the silicone). Allow a minimum of 24 hours curing time before flexing the connection.



SSR-C Red Silicone  
9.5 FL. OZ. Cartridge  
Item# 5113

4. For an airtight connection, apply duct sealer over the metal joint. Refer to Duro Dyne's Adhesive Duct Sealer Catalog for further information on a suitable Duct Sealer.

Finished Joint

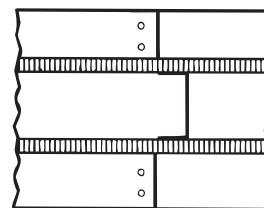

## DURO STAPLER AND STAPLES

Duro Dyne's Flexible Connectors are preassembled metal-to-fabric which eliminates this difficult, time consuming shop operation. After forming the metal, the overlap can be riveted, screwed or spot welded.

The fabric seam can be quickly closed using the handy Duro Stapler. The result is a sturdily constructed, low cost flexible connector which meets engineering specifications. See Fabricating A Flexible Connection above.



ITEM# 10065



ITEM# 10059

# VANE RAIL®



Air travelling throughout a duct is slowed up when it reaches a right turn angle. This "slow-up" is detrimental to the efficiency of the duct system, therefore air turning vane assemblies are used to guide air evenly around such turns. With today's high labor costs, it is expensive for shops to produce their own air turning assemblies. That is why Duro Dyne Vane Rail is a major contribution to sheet metal shops that require efficient, yet inexpensive air turning assemblies. With Duro Vane Rail, which is a pre-fab side rail, layout time is eliminated. Vanes can be sheared from scrap metal without tab cutting, and quickly assembled to rails with only one blow of a ball peen hammer.

Duro Dyne Vane Rail is made of 24 gauge galvanized steel, is precision-stamped and slotted, assuring uniform spacing of vanes, and is the fastest, easiest, most economical construction of vane assemblies. Duro Dyne Vane Rail is specially embossed adding strength and sturdiness to the finished section. Vane Rail can be used to make quality turning vanes for any size elbow including change of size elbows.

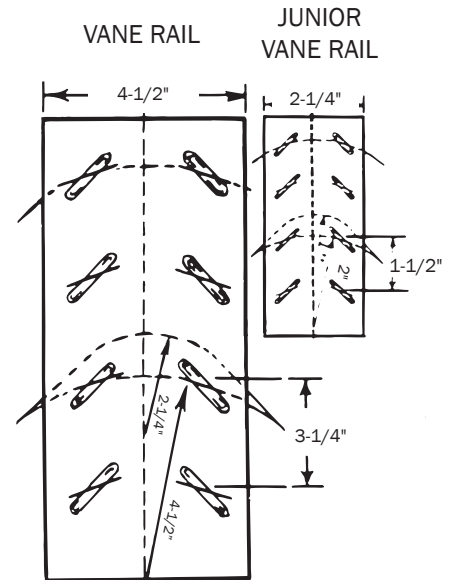

VANE RAIL®		
ITEM	CODE	DESCRIPTION
4002	VR2	Vane Rail - 100 ft. Continuous Coils
4003	JVR2	Junior Vane Rail - Two 100 ft. Continuous Coils (Easily Dispensed Together or Singulary)
4007	VR2SS	300L Series Stainless Steel Vane Rail
4008	VR2AL	Aluminum Vane Rail

## FABRICATING AIR TURNING VANES



1. Shear and form the vanes as indicated. Position the vanes in the Vane Rail slot. The slots force the vanes to take the correct curve.

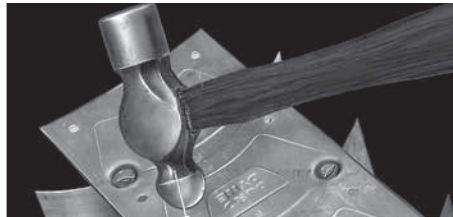

2. Secure the protruding vane with a ball peen hammer.



3. An extra deep depression in Vane Rail allows for superior gripping action. The vane assembly is then fastened in the elbow.

# FLEXIBLE DUCT CONNECTOR CRADLE & SHEAR

The Duro Dyne Flexible Duct Connector Cradle can relieve many of the difficulties associated with the handling of flexible connector. Duro Dyne's Model FDCAB3 keeps up to three rolls of 4x4x4 flexible duct connector or vane rail within easy reach, anywhere in the shop. Heavy Duty 360° caster wheels make movement around the shop possible, and ball transfers quickly dispense connector with a simple pull. A foot actuated brake locks the FDCAB3 in place when dispensing the connector. The shear attachment cuts the duct connector accurately and effortlessly.

- Handles all common configurations of Duro Dyne Flexible Duct Connector
- Wheels lock to prevent dispenser from moving
- 360° casters for easy maneuverability around the shop
- Capacity for up to 3 rolls of Duro Dyne Flexible Duct Connector or Vane Rail
- Ball bearing rollers for effortless dispensing
- Shear attachment Dimensions: 35 1/2" high to table x 40" wide x 56" long

FDCAB3		
ITEM	CODE	DESCRIPTION
43008	FDCAB3	Flexible Duct Connector Cradle with Shear
43010	FDCS-10	Flexible Duct Connector Shear



Please Visit Our Website  
**www.durodyne.com**  
for the most current product information.

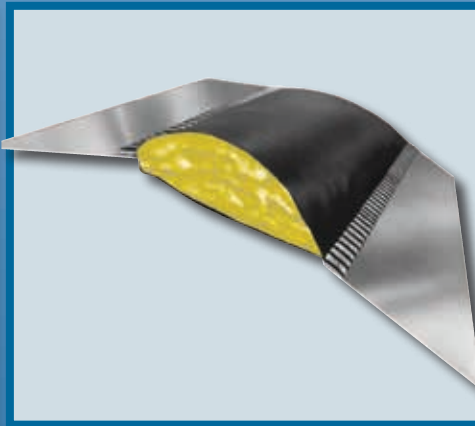
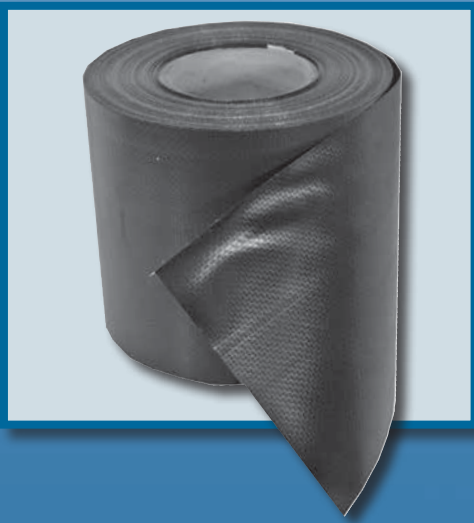

© Duro Dyne Corp.  
10/18/17  
BB008402

Duro Dyne East Division, Bay Shore, NY 631-249-9000 Fax: 631-249-8346  
Duro Dyne Midwest Division, Hamilton, OH 513-870-6000 Fax: 513-870-6005  
Duro Dyne West Division, Fontana, CA 562-926-1774 Fax: 562-926-5778  
Duro Dyne Canada, Lachine, Quebec, Canada 514-422-9760 Fax: 514-636-0328  
www.durodyne.com E-mail: durodyne@durodyne.com